



301

HORIZONTAL COLUMN ACOUSTICS
横柱型扬声器

技术参数:

单元: 2 x 100 mm (4 inch) EMX单元

1 x 27 mm (1.1 inch) 单元

频率范围(-10dB): 65 Hz ~ 18 kHz

额定阻抗: 8 ohm

功率: 100W/200W/400W (连续/节目/峰值)

灵敏度(1W@1M): 90 dB

峰值声压级¹: 122dB

覆盖角: 水平:110° 垂直:50°

音箱材质: 全金属复合材料

颜色: 深灰色:301

白 色:301/W

黑 色:301/B

外形尺寸(WxHxD): 500 x 130 x 152mm

净重: 4.8kg



频率响应曲线:

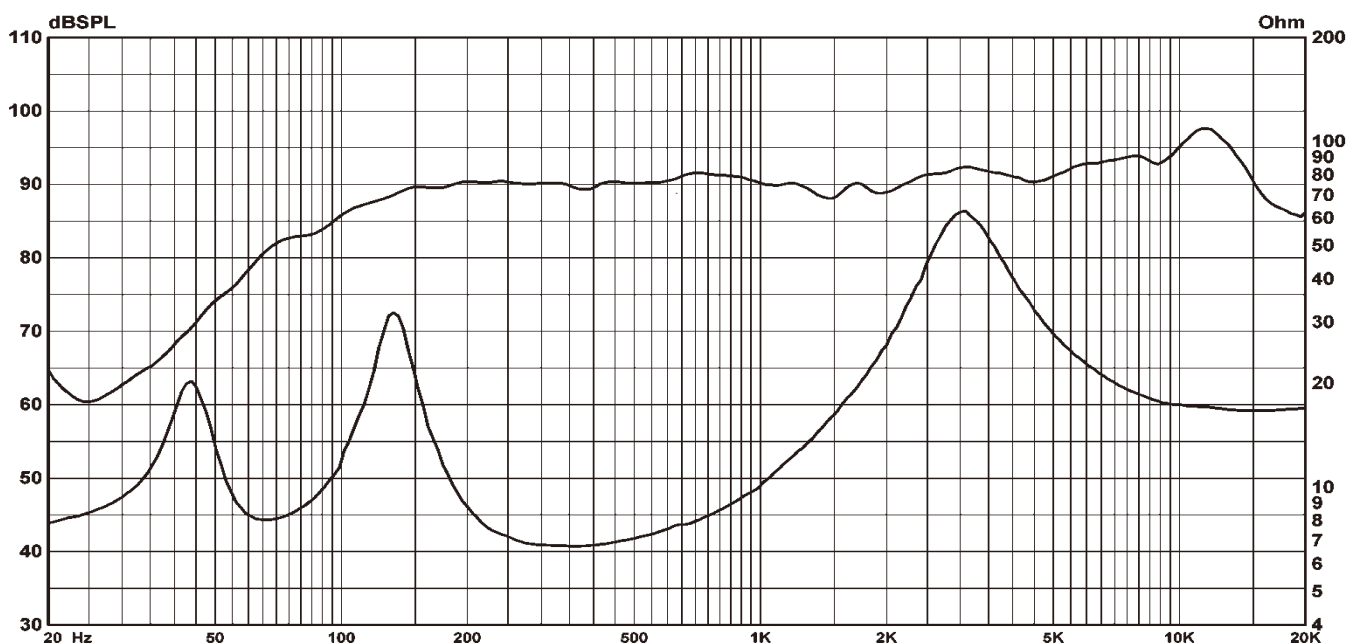

1. 使用12dB峰值因子粉噪信号测试得到, 半自由场。

覆盖角度:

Horizontal 1/3 Octave Polars

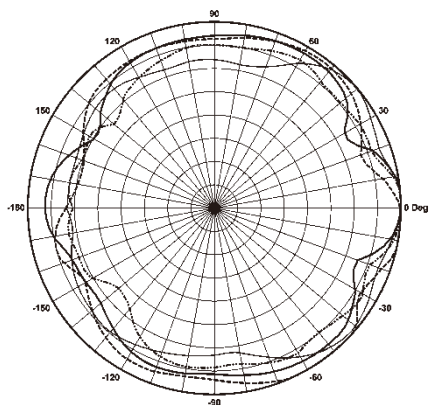

Curve	Freq
—	1.25K
- - -	1.60K
—	2.00K
- - -	2.50K

Vertical 1/3 Octave Polars

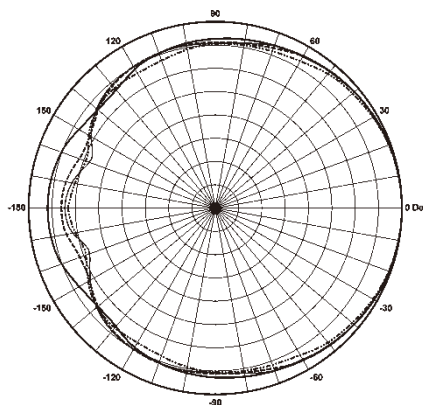

Curve	Freq
—	1.25K
- - -	1.60K
—	2.00K
- - -	2.50K

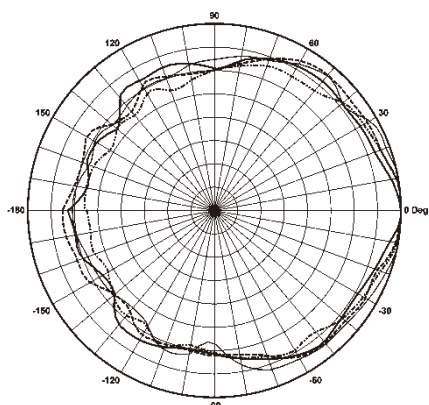

Curve	Freq
—	3.20K
- - -	4.00K
—	5.00K
- - -	6.00K

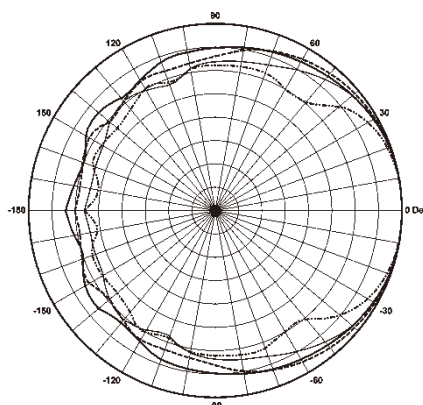

Curve	Freq
—	3.20K
- - -	4.00K
—	5.00K
- - -	6.00K

产品尺寸:

