



# CRA12/12V

CRA 通用系列  
紧凑型恒定指向性阵列音箱

## 技术参数：

单元：2 x 100 mm (4 inch) EMX单元

频率范围 (-10dB)：80 Hz ~ 20 kHz

额定阻抗：8 ohm

功率：75W/150W/300W (连续/节目/峰值)

灵敏度(1W@1M)：90 dB

峰值声压级<sup>1</sup>：121 dB

覆盖角：水平:120° 垂直:30°

音箱材质：全金属复合材料

可选：CRA12V(定压)

CRA12WP(防水等级IP56)

变压器档位：70V：60W,30W,15W,7.5W

100V：60W,30W,15W

颜色：深灰色:CRA12

白 色:CRA12/W

黑 色:CRA12/B

外形尺寸(HxWxD)：310x 130 x 152mm

净重：3.5kg/4.0kg (定压)



## 频率响应曲线：

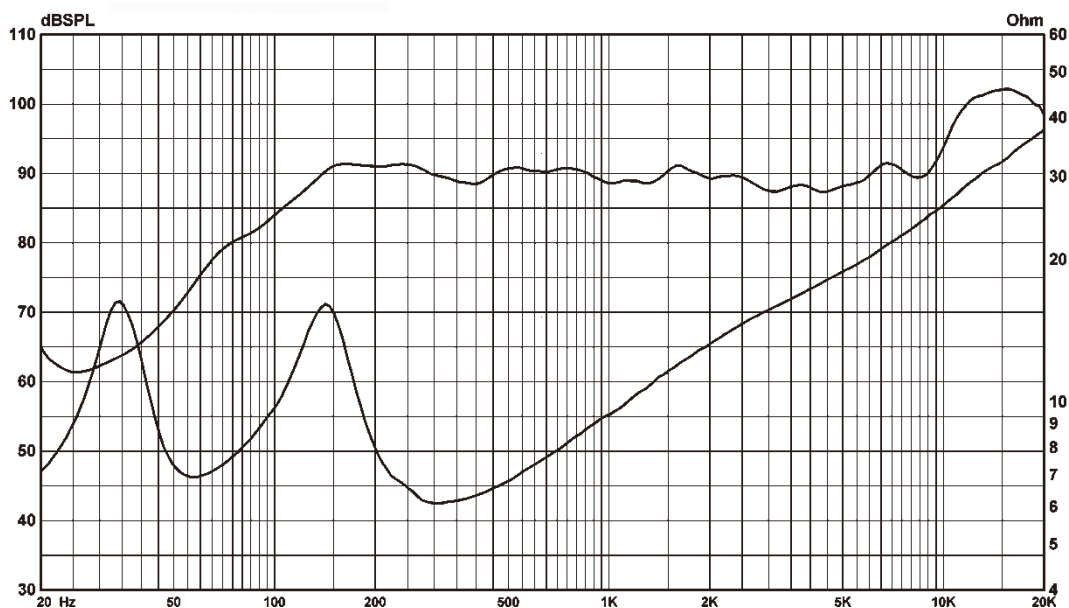

1. 使用12dB峰值因子粉噪信号测试得到，半自由场。



# CRA12/12V

CRA 通用系列  
紧凑型恒定指向性阵列音箱

## 覆盖角度:

Horizontal 1/3 Octave Polars

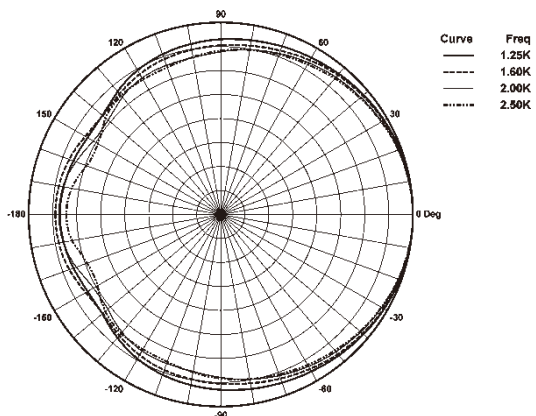

Vertical 1/3 Octave Polars

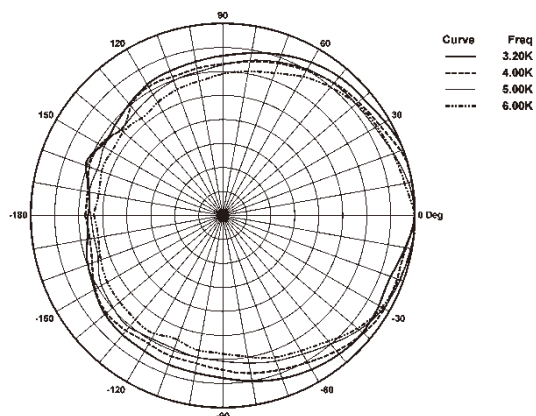
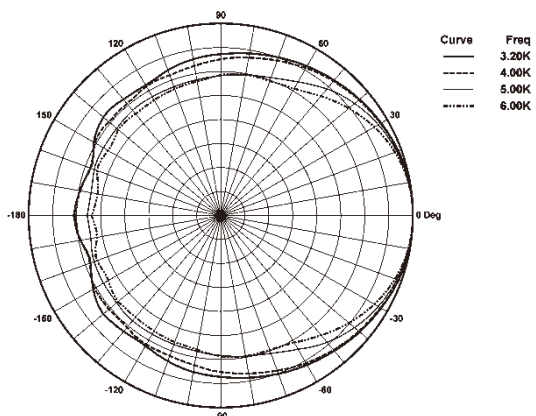
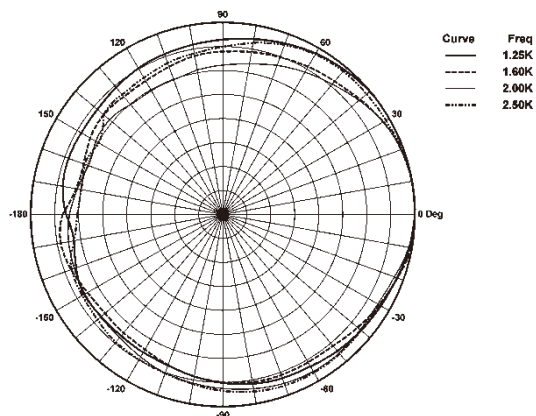

## 产品尺寸:

